

Problem 4.3-7 Determine the values of the node voltages, v_1 and v_2 . Determine the values of the currents i_a and i_b .

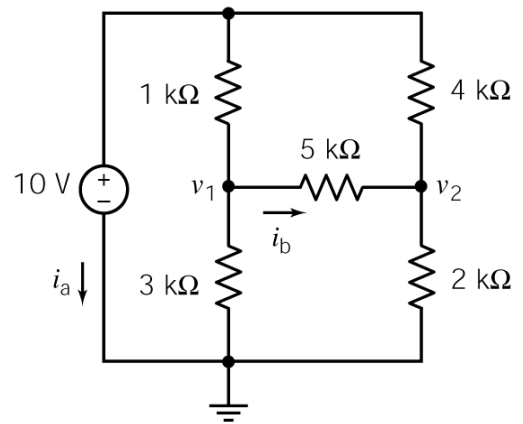

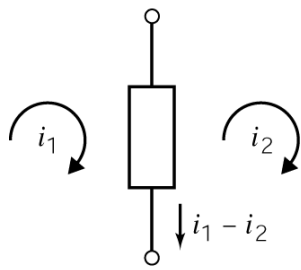

(a)

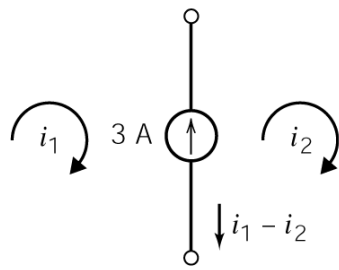

(b)

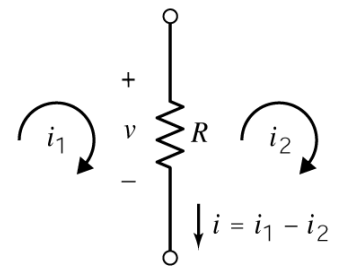

(c)

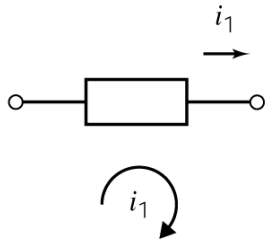

(a)

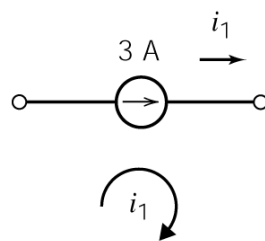

(b)

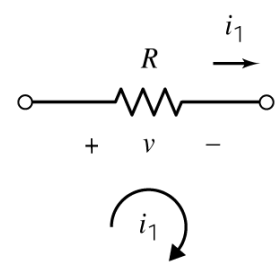

(c)

Problem 4.6-3 Write and solve mesh equations to find v_2 for this circuit:

